

# Introduction to TCloud and DESIS Data

## May 21, 2020

# Outline

1. Introduction of the DESIS Team
2. Brief Overview of MUSES and DESIS
3. TCloud Overview and Demonstration
4. Review of Delivered Data
5. Introduction to Data Processing



# DESIS Team



- ▶ [Jack Ickes](#)  
Teledyne Brown Engineering  
Senior Vice President, Geospatial Solutions  
Program Manager



- ▶ [Yvonne Ivey](#)  
Booz Allen Hamilton  
NASA Earth Science Data System Program  
POC for DESIS Data Access



- ▶ [Kara Burch](#)  
Innovative Imaging and Research (I2R)  
Senior Scientist  
Technical POC for Image Quality & Instrument Performance



- ▶ [Heath Lester](#)  
Teledyne Brown Engineering  
Operations Manager  
Acquisition Coordinator

# MUSES and DESIS Overview



# Multi-User System for Earth Sensing (MUSES)

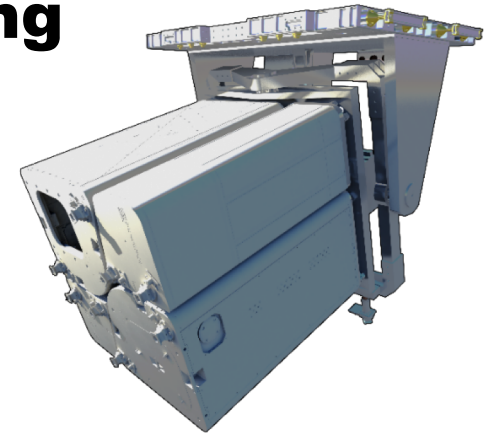

- ▶ Precision pointing platform, designed in cooperation with NASA, for low-cost earth observation from the International Space Station (ISS).
- ▶ Comprised of Platform (ISS external) and Server (ISS internal)
- ▶ Up to 4 robotically installed instruments.
  - Payload can be removed and returned to earth for analysis or reuse.
- ▶ Total data downlink ~225 GB/day.
  - Onboard processing option.
- ▶ < 12 Months: Contract to Launch.
  - ~ 1/3 the cost of a free-flyer mission.

Characteristic	MUSES Performance Target
Field of Regard	Outboard Cross-Track: 5°
	Inboard Cross-Track: 45°
	Along-Track: +/- 25°
Thermal Control	Passive
Star Tracker	Sodern SED26
Inertial Measurement Unit	Honeywell Miniature Inertial Measurement Unit (MIMU)
Precision Time	Sourced from the ISS GPS, ≤ ± 250 μsec to MUSES instruments
Pointing Accuracy	≤ ± 60 arc seconds
Pointing Knowledge	≤ ± 30 arc seconds (~ 60 m on ground from 400 km altitude)
Location knowledge	Sourced from the ISS GPS, ± 50 meters, RMS
Orbit	51.6° Inclination, 400 km altitude ± 5% (nominal)
Data Processing	Linux Server on-board ISS with redundant 6 TB storage
Daily Downlink Capacity	225 GB

# Earth Observation From the ISS – Why It Works/Challenges

## ► Benefits

- Coverage of ~90% of populated Earth.
- Coverage of tropics, frequent revisit times off-noon allow for reduced-cloud image acquisition.
- Orbit enables acquisitions at different times of day, useful for BRDF or diurnal dynamics.
- Upgrade, repair and exchange of instruments as technology and/or markets evolution.
- Traditional barriers to entry are minimized.

## ► Challenges

- Above 55° N and below 52° S not covered in orbit.
- Revisit time has a beat frequency that depends on latitude.



# DESIS Overview

## ▶ Cooperative effort between the German Aerospace Center (DLR) and Teledyne Brown Engineering (TBE)

- MUSES first payload – Launched June of 2018.
- Teledyne has commercial rights to imagery while DLR retains the rights for scientific use.

## ▶ DLR Earth Sensing Imaging Spectrometer (DESIS)

- 235 bands with 2.55 nm sampling over the VNIR spectral region (400-1000 nm).
- 30 m GSD @ ISS 400 km orbit.
- Sensor pointing  $\pm 15^\circ$  along track, enables BRDF and stereo acquisitions.
- Push Broom Sensor: Maximum length of a single strip  $\sim 3000$  km.
- Each strip is broken into  $1024 \times 1024$  pixel tiles, or  $30 \times 30$  km.

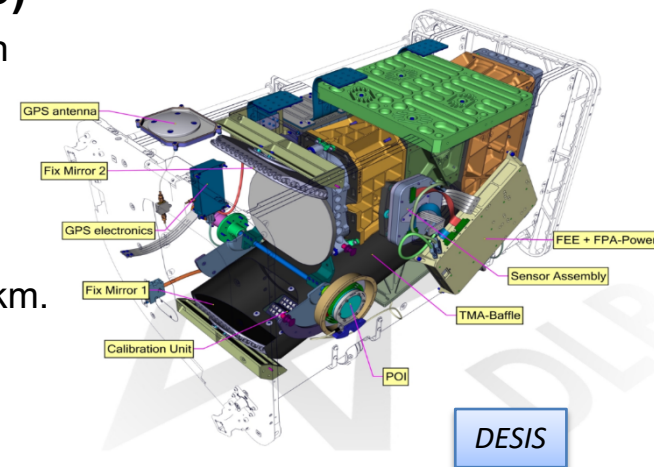
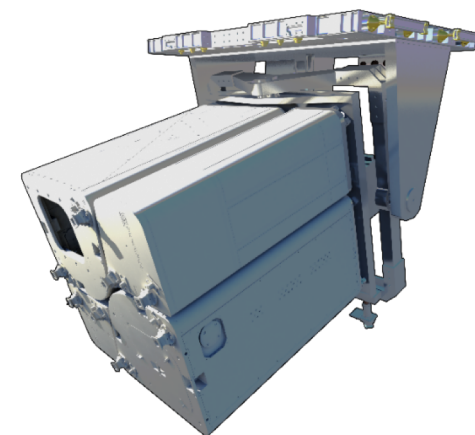

# DESI Specifications

Parameter	DESI Specification (Commissioning Phase)
Orbit	not Sun-synchronous, 51.6°, 400 ± 5 km, 93 min, no repeat cycle
Coverage	55° N to 52° S
Tilt (across-track, along-track)	+45° to -5°, -40° to +40° by MUSES and DESIS
Sensor Pointing	±15° along-track to enable BRDF or Stereo acquisitions
Spectral coverage	402 nm to 1000 nm (Part of FPA defective at low wavelengths)
Number of spectral channels	235 (no binning); 118 (binning 2); 79 (binning 3); 60 (binning 4)
Spectral Sampling resolution	2.55 nm (w/o binning); ~10.2 nm (binning 4)
Full Width Half Maximum (FWHM)	~3.5 nm (w/o binning); ~10.5 nm (binning 4)
Radiometric resolution	12 bits + 1 bit gain
Radiometric Accuracy	±10% (based on on-ground calibration and with support of inflight radiometric calibration; Expect ±5%)
Radiometric Linearity	99%
Swath	30 km
Spatial resolution, pixels	30 m, 1024 pixels (@400 km)
Geometric accuracy	~20 m with GCPs ~300 m - 400 m w/o GCPs (i.e. water only collects)
MTF @ Nyquist	30%-40% based on on-ground calibration / static MTF without smearing effects / wavelength depending
Signal-to-Noise ratio (albedo 0.3 @ 550 nm)	195 (w/o binning) 386 (4 binning)
Solar zenith angle restrictions (for L2A level processing)	> 55° produces reduced quality L2A product > 65° produces low quality L2A product > 70° not processible to L2A



# TCloud

## Overview and Demonstration

# TCloud Overview

- ▶ **TCloud is a Teledyne Brown Engineering – Geospatial Solutions cloud-based data management and distribution system for geospatial imagery.**
  - Front end – user interface
  - Back end – data processing
- ▶ **Allows approved users to submit DESIS sensor tasking requests and/or order archived DESIS data and retrieve the requested data.**
- ▶ **Allows for post-processing of the data in multiple ways.**

# TCloud Demonstration

TCloud Website: <https://teledyne.tcloudhost.com>

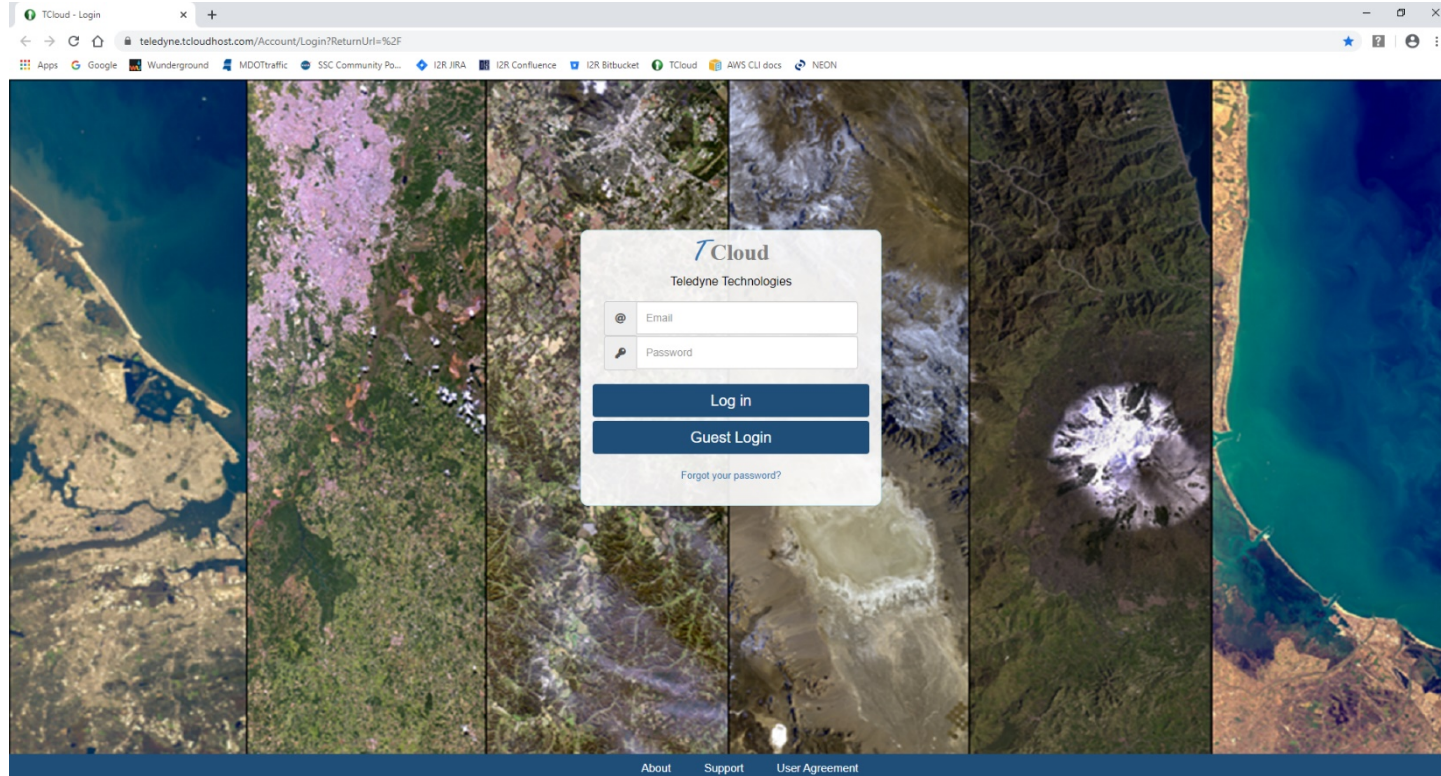

# DESI

# Data Delivery



# Product Overview

- ▶ **DESIIS L1A raw data stored in archive**
  - Not an available product
- ▶ **Several levels of processing available for end-users**
  - L1B Radiance
  - L1C Orthorectified Radiance
  - L2A Surface Reflectance (*Coming Soon*)
- ▶ **Processing applied on-the-fly in the online archive when data is ordered**

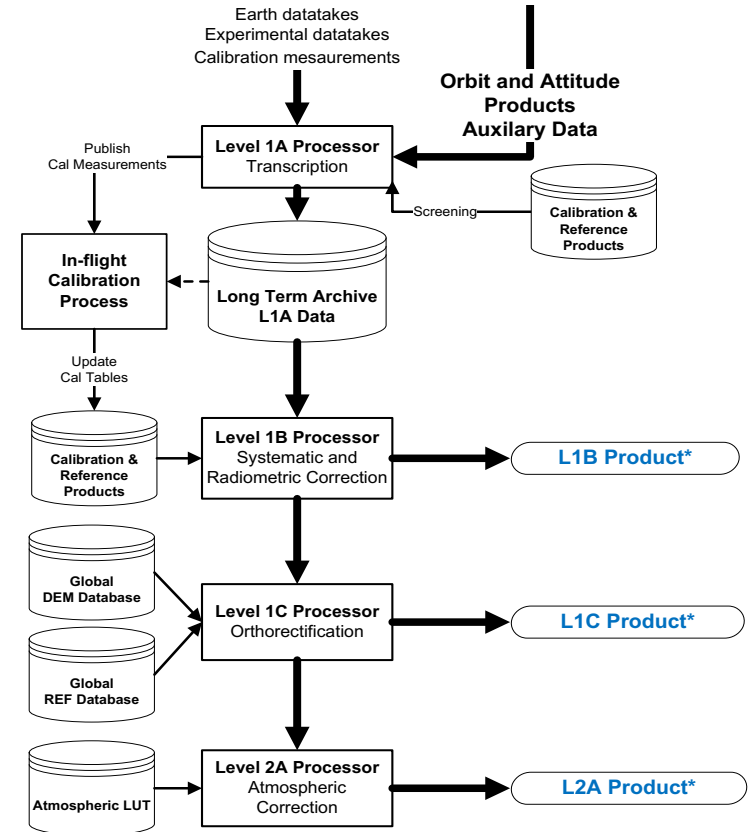

# Order Download

- ▶ **DESI** data ordered from TCloud is delivered either via user download from the TCloud repository or to an **AWS S3** bucket
  - Each requested product/tile is provided as a separate zip file
  - Users are sent an email when ordered data is available for download
  - Users may also download directly from their order history

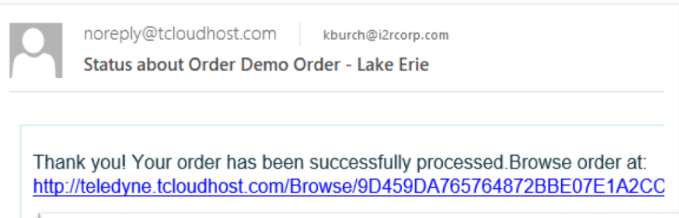

noreply@tcloudhost.com | kburch@i2rcorp.com  
Status about Order Demo Order - Lake Erie

Thank you! Your order has been successfully processed. Browse order at:  
<http://teledyne.tcloudhost.com/Browse/9D459DA765764872BBE07E1A2CC3>

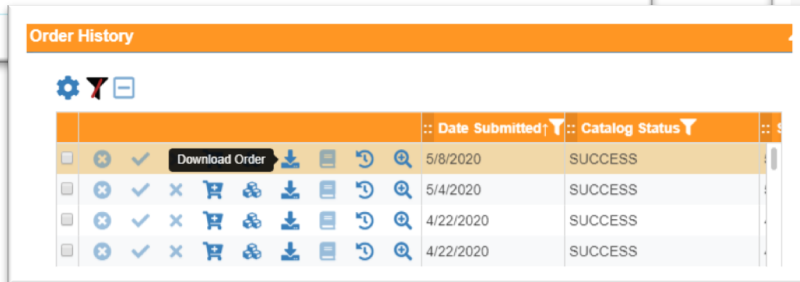

Order History		
	Date Submitted	Catalog Status
<input type="checkbox"/> [Download Order]	5/8/2020	SUCCESS
<input type="checkbox"/>	5/4/2020	SUCCESS
<input type="checkbox"/>	4/22/2020	SUCCESS
<input type="checkbox"/>	4/22/2020	SUCCESS

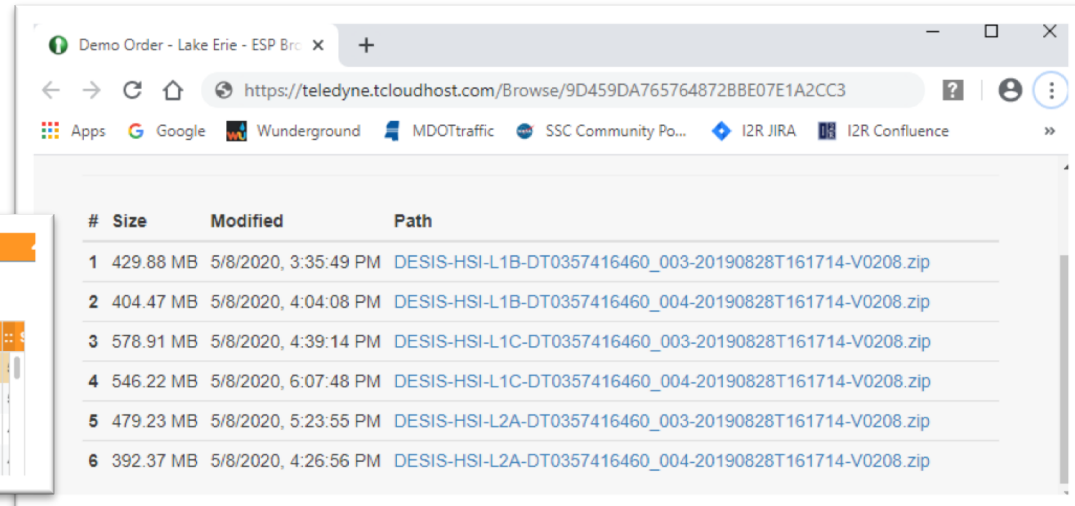

Demo Order - Lake Erie - ESP Bro x +

https://teledyne.tcloudhost.com/Browse/9D459DA765764872BBE07E1A2CC3

#	Size	Modified	Path
1	429.88 MB	5/8/2020, 3:35:49 PM	DESI-HSI-L1B-DT0357416460_003-20190828T161714-V0208.zip
2	404.47 MB	5/8/2020, 4:04:08 PM	DESI-HSI-L1B-DT0357416460_004-20190828T161714-V0208.zip
3	578.91 MB	5/8/2020, 4:39:14 PM	DESI-HSI-L1C-DT0357416460_003-20190828T161714-V0208.zip
4	546.22 MB	5/8/2020, 6:07:48 PM	DESI-HSI-L1C-DT0357416460_004-20190828T161714-V0208.zip
5	479.23 MB	5/8/2020, 5:23:55 PM	DESI-HSI-L2A-DT0357416460_003-20190828T161714-V0208.zip
6	392.37 MB	5/8/2020, 4:26:56 PM	DESI-HSI-L2A-DT0357416460_004-20190828T161714-V0208.zip

# DESIS Delivered Files

## ▶ Each delivered zip file contains:

- QuickLook Image
- Metadata File
- Quality Image
- Ancillary Files
- Hyperspectral Image

## ▶ Expected zip file data volumes:

- Full spectral resolution data
  - 400 – 600 MB
- Binned x 4 (10.2 nm)
  - 100 – 200 MB

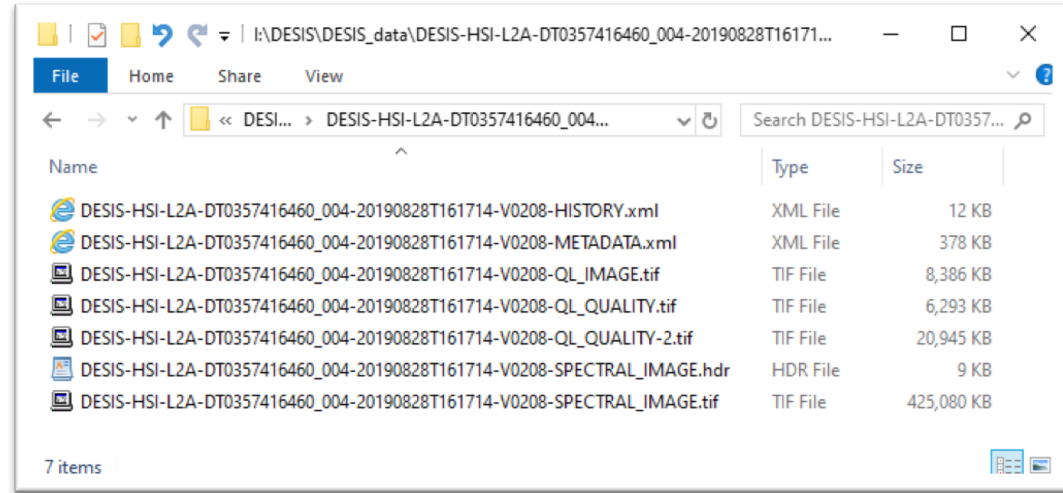

### **File Naming Convention**

DESIS-HSI-L<XX>-DT<nnnnnnnnnn>\_<fff>-<yyyymmdd>T<hhmmss>-V<vvvv>-<file type>.<ext>

Where, <XX> is the product level (1B, 1C or 2A)

<nnnnnnnnnn> is a unique identifier from the planning system

<fff> is the tile number of the image strip

<yyyymmdd> is the date in year, month, day format

<hhmmss> is the time in UTC (hour, minute, second)

<vvvv> is the image processor version number

<file type> is the type of file (SPECTRAL\_IMAGE, QL\_QUALITY, QL\_IMAGE, or METADATA)

<ext> is the file extension (tif, xml, or hdr)

# QuickLook Image

- ▶ **Each delivered tile includes a QuickLook image tif file (\*QL\_Image.tif)**
  - 3-band (~500 nm, 650 nm and 850nm) 8-bit image
  
- ▶ **Viewable using standard and image processing software**
  - Windows Photo Viewer
  - ENVI
  - Imagine
  - MATLAB



*Lake Erie/Toledo OH, August 28, 2019  
L2A Surface Reflectance QuickLook Image*



# Metadata File

- ▶ **Metadata includes information about the sensor, acquisition and processing in xml format (\*METADATA.xml)**
  - Image corner coordinates, acquisition times and sun and sensor geometry at the time of acquisition are provided
  - Center wavelengths, spectral band information, and scale factors (gains and offsets) are provided for each band
  - Information relating to the image orthorectification is also included for L1C and higher products
- ▶ **Text file viewable using web browser (e.g. Internet Explorer) or text editor (e.g. WordPad or Notepad)**
- ▶ **Metadata fields described in Section 5.1 of DESIS Product Specifications:**  
[https://tbe.com/documents/PDFs/DESIIS\\_Specifications.pdf](https://tbe.com/documents/PDFs/DESIIS_Specifications.pdf)

# Metadata File Contents (1)

## Metadata file contents

- File information
- Processing parameters  
(product type,  
resampling, map  
projection)
- Base parameters  
(location, time,  
processing level)

```

<?xml version="1.0" encoding="UTF-8" ?>
- <hsi_doc xsi:noNamespaceSchemaLocation="DESIS_schema_L2A_02.xsd"
  xmlns:xsi="http://www.w3.org/2001/XMLSchema-instance">
  - <metadata>
    <name>DESIS-HSI-L2A-DT0357416460_004-20190828T161714-V0208-
      METADATA.xml</name>
    <comment>DESIS_Hyperspectral_Image_atmospheric_corrected_data</comment>
    <copyright>TBE</copyright>
    <license>DLR_internal_usage</license>
  </metadata>
  - <processing>
    <coRegistration>none</coRegistration>
    <mapProjection>UTM_Zone_of_Scene_Center</mapProjection>
    <imageResampling>Bilinear_Interpolation</imageResampling>
    <backgroundValue>-32768</backgroundValue>
    <swBinning>>false</swBinning>
    <versionDEM>SRTM_C1ARC</versionDEM>
    <versionREF>GMB</versionREF>
    <terrainCorrection>No</terrainCorrection>
    <ozoneValue>330</ozoneValue>
    <productType>L2A</productType>
    <test>>true</test>
  </processing>
  - <base>
    <version>02.08</version>
    <l1aVersion>02.03</l1aVersion>
    <sphere>earth</sphere>
    <size>1032</size>
    <level>L2A</level>
    <format>TIF</format>
    - <spatialCoverage>
      + <boundingPolygon>
    </spatialCoverage>
    <altitudeCoverage>423612.1</altitudeCoverage>
    - <temporalCoverage>
      <startTime>2019-08-28T16:18:52.851925Z</startTime>
      <endTime>2019-08-28T16:18:57.197898Z</endTime>
    </temporalCoverage>
  </base>
  + <specific>
</hsi_doc>

```

Bounding Polygon  
Coordinates

Specific Parameters  
continued on next slide

Acquisition Time

# Metadata File Contents (2)

## Specific Parameters

- Sensor information
- Orbit and processing information
- Product dependent processing information
- Acquisition information (sun and sensor geometry)

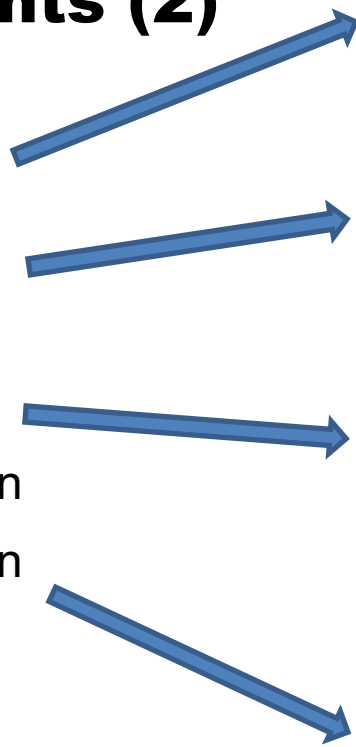

```

- <specific>
  <mission>DESIS</mission>
  <satelliteID>ISS</satelliteID>
  <sensor>HSI</sensor>
  <sensorMaxBands>235</sensorMaxBands>
  <acquisitionMode>image_strip_mode</acquisitionMode>
  <requestID>0000</requestID>
  <dataakeID>0357416460</dataakeID>
  <imageID>0357416460004</imageID>
  <tileID>004</tileID>
  <numberOfTiles>9</numberOfTiles>
  <numberOfBands>235</numberOfBands>
  + <bandCharacterisation>
    <pixelSize unit="m">30.000000000000000</pixelSize>
    <widthOfScene>1390</widthOfScene>
    <heightOfScene>1542</heightOfScene>
    <missionPhase>routine</missionPhase>
    <orbitDirection>DESCENDING</orbitDirection>
    <orbitType>precision</orbitType>
    <processingDateTime>2020-05-08T20:23:12.380856Z</processingDateTime>
    <processingCenter>TBE</processingCenter>
    <processingNode>ip-172-31-68-195</processingNode>
    <processable>1</processable>
  + <terrain>
  + <waterVapour>
    <stripingBanding>0</stripingBanding>
    <generalArtifacts>0</generalArtifacts>
    <defectivePixels>0</defectivePixels>
    <smileIndicator>255</smileIndicator>
    <orthoRMSE_x>20.169267</orthoRMSE_x>
    <orthoRMSE_y>21.295550</orthoRMSE_y>
    <numPointsGCP>23</numPointsGCP>
    <numPointsICP>71</numPointsICP>
    <matchingMethod>BRISK</matchingMethod>
  + <visibility>
  + <haze>
  + <clouds>
  + <cloudShadow>
  + <topoShadow>
    <meanAerosolOpticalThickness>0.292209098684</meanAerosolOpticalThickness>
    <aerosolType>rural</aerosolType>
    <season>summer</season>
    <sunAzimuthAngle>146.584794</sunAzimuthAngle>
    <sunZenithAngle>36.338388</sunZenithAngle>
    <sceneAzimuthAngle>118.715716</sceneAzimuthAngle>
    <sceneIncidenceAngle>6.44</sceneIncidenceAngle>
    <lowGainFactor>2</lowGainFactor>
    <highGainFactor>10</highGainFactor>
    <configFPA>rolling_shutter</configFPA>
    <pointingMirrorAngle>0.239648</pointingMirrorAngle>
    <qualitySZA>normal</qualitySZA>
  + <qualityIndicator>
  + <...

```

*Spectral Band Information (next slide)*

## Metadata File Contents (3)

### ▶ Band Characteristics provided for each spectral band

- Center wavelength (nm)
- Band FWHM (nm)
- Band spectral response and corresponding wavelengths
- Gain and Offset
  - For conversion to radiance or reflectance
- % dead or suspicious pixels

```

- <band>
  <bandNumber>10</bandNumber>
  <wavelengthCenterOfBand>425.3</wavelengthCenterOfBand>
  <wavelengthWidthOfBand>3.6</wavelengthWidthOfBand>
  <response>1.31e-05, 2.15e-05, 3.49e-05, 5.58e-05, 8.77e-05, 1.36e-04, 2.07e-04,
    3.12e-04, 4.62e-04, 6.73e-04, 9.66e-04, 1.36e-03, 1.90e-03, 2.60e-03, 3.51e-03,
    4.66e-03, 6.09e-03, 7.83e-03, 9.91e-03, 1.24e-02, 1.52e-02, 1.83e-02, 2.17e-02,
    2.54e-02, 2.93e-02, 3.31e-02, 3.69e-02, 4.05e-02, 4.37e-02, 4.64e-02, 4.85e-02,
    4.99e-02, 5.05e-02, 5.03e-02, 4.93e-02, 4.75e-02, 4.51e-02, 4.22e-02, 3.87e-02,
    3.50e-02, 3.12e-02, 2.73e-02, 2.36e-02, 2.00e-02, 1.67e-02, 1.37e-02, 1.11e-02,
    8.83e-03, 6.92e-03, 5.34e-03, 4.05e-03, 3.03e-03, 2.23e-03, 1.61e-03, 1.15e-03,
    8.08e-04, 5.58e-04, 3.80e-04, 2.55e-04, 1.68e-04, 1.09e-04, 7.01e-05, 4.42e-05,
    2.75e-05, 1.68e-05, 1.02e-05</response>
  <wavelengths>418.80, 419.00, 419.20, 419.40, 419.60, 419.80, 420.00, 420.20,
    420.40, 420.60, 420.80, 421.00, 421.20, 421.40, 421.60, 421.80, 422.00, 422.20,
    422.40, 422.60, 422.80, 423.00, 423.20, 423.40, 423.60, 423.80, 424.00, 424.20,
    424.40, 424.60, 424.80, 425.00, 425.20, 425.40, 425.60, 425.80, 426.00, 426.20,
    426.40, 426.60, 426.80, 427.00, 427.20, 427.40, 427.60, 427.80, 428.00, 428.20,
    428.40, 428.60, 428.80, 429.00, 429.20, 429.40, 429.60, 429.80, 430.00, 430.20,
    430.40, 430.60, 430.80, 431.00, 431.20, 431.40, 431.60, 431.80</wavelengths>
  <gainOfBand>0.0001</gainOfBand>
  <offsetOfBand>0.0</offsetOfBand>
  <deadPixels>0.0</deadPixels>
  <suspiciousPixel>0.0</suspiciousPixel>
</band>
- <band>
  <bandNumber>11</bandNumber>

```



# Quality File

- ▶ **Quality file provides location of defect or suspect pixels, and identifies the quality issue (\*QL\_QUALITY.tif)**
  - 8-bit tif with same number of bands as hyperspectral image
  - Each bit provides a flag for possible image quality issues
    - Pixel with quality issue (and surrounding pixels) have appropriate bit set to 1

Bit Value	Quality Flag
7	Not Used
6	Unreliable Calibration
5	Manufacturing Defect
4	No Data
3	Low Radiance Value
2	High Radiance Value
1	Suspicious
0	Dead

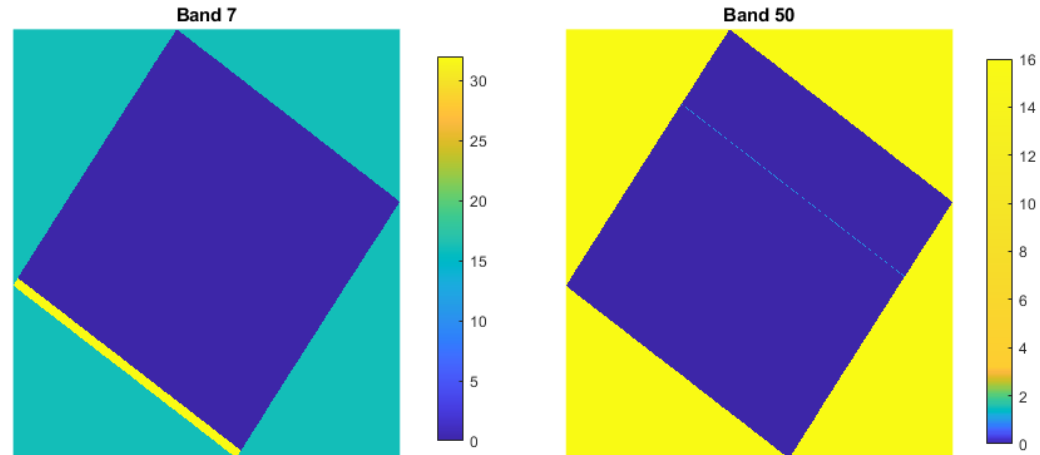

# L2A Quality-2 File

- ▶ **L2A surface reflectance products are delivered with an additional quality file in a 10-band 8-bit tif (\*QL\_QUALITY-2.tif)**
  - Per pixel classification with 8 mask layers (0=false, 1=true)
  - Aerosol optical depth at 550 nm (layer 9, scaled by 100)
  - Water vapor in cm (layer 10, scaled by 42)

Layer	Pixel Classification
1	Shadow
2	Clear Land
3	Snow
4	Haze over land
5	Haze over water
6	Cloud over land
7	Cloud over water
8	Water

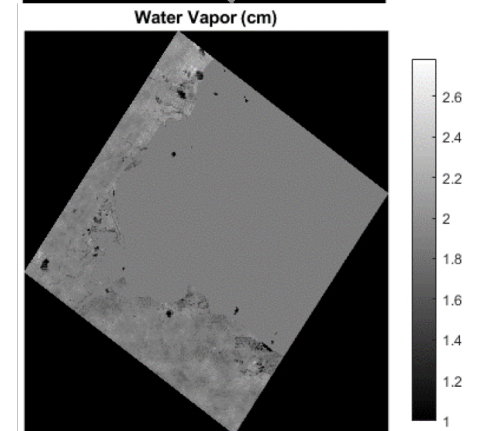
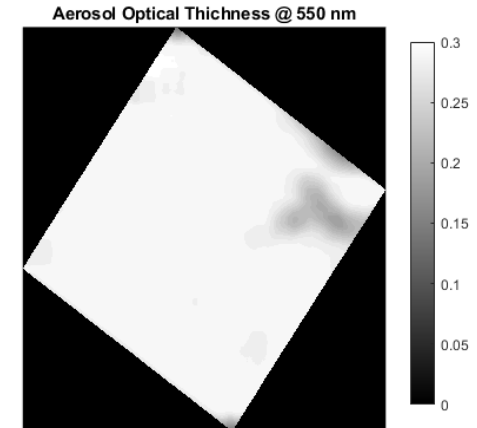
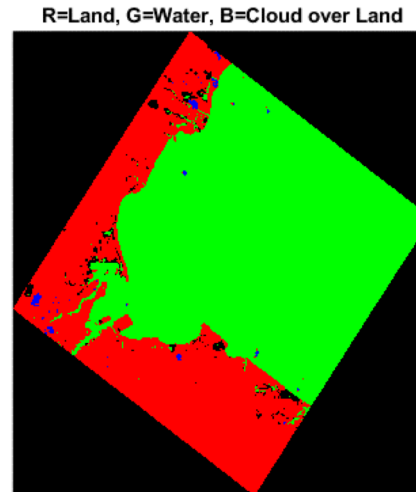

# Ancillary Files

- ▶ **ENVI format header file (\*.hdr)**
  - Includes projection information for rectified image display
  - Includes per band center wavelengths and scale factors required to convert data to radiance or reflectance
  
- ▶ **Product history file (\*HISTORY.xml)**
  - Contains information about the executed processing steps and the algorithms and files used to produce the data product

# Hyperspectral Image

- ▶ **Spectral image file contains the hyperspectral data (\*SPECTRAL\_IMAGE.tif)**
  - 16-bit tif with a separate image layer per hyperspectral band
  - Scaled DN
- ▶ **Requires image processing software or specialized reader to view**
  - ENVI
  - Imagine
  - MATLAB/Python

R=650nm, G=550nm, B=450nm

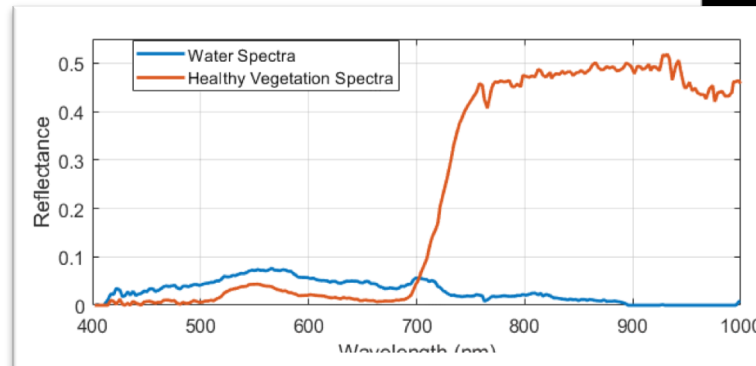
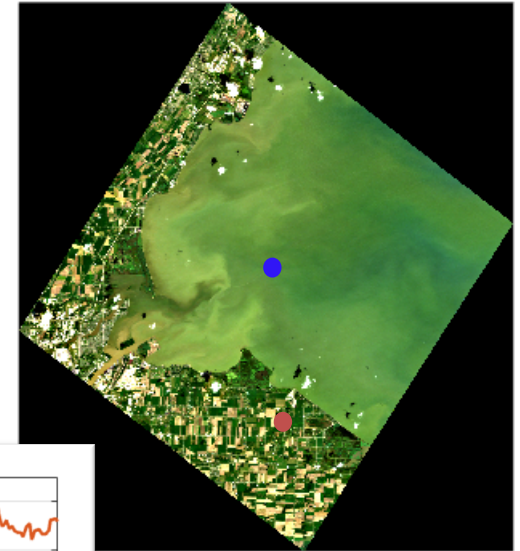

# DESI

# Data Processing Introduction

# Image Processing Software

- ▶ **Specialized software is required to import, visualize and generate products from scientific image data**
  - Software enables full exploitation of geometric and spectral properties of remotely sensed data
- ▶ **Software specifically designed for image processing**
  - ENVI (L3 Harris) developed for hyperspectral imagery analysis
  - ERDAS Imagine
- ▶ **Programming software with significant image processing capability**
  - MATLAB (MathWorks)
  - Python (open source)

*Examples will be shown using hyperspectral imagery in ENVI*



# Image Visualization

- ▶ **ENVI can be used to view the image**
  - Band selection for RGB display
- ▶ **Spectral profiles can also be viewed**
  - Included .hdr file automatically read and used to define wavelengths

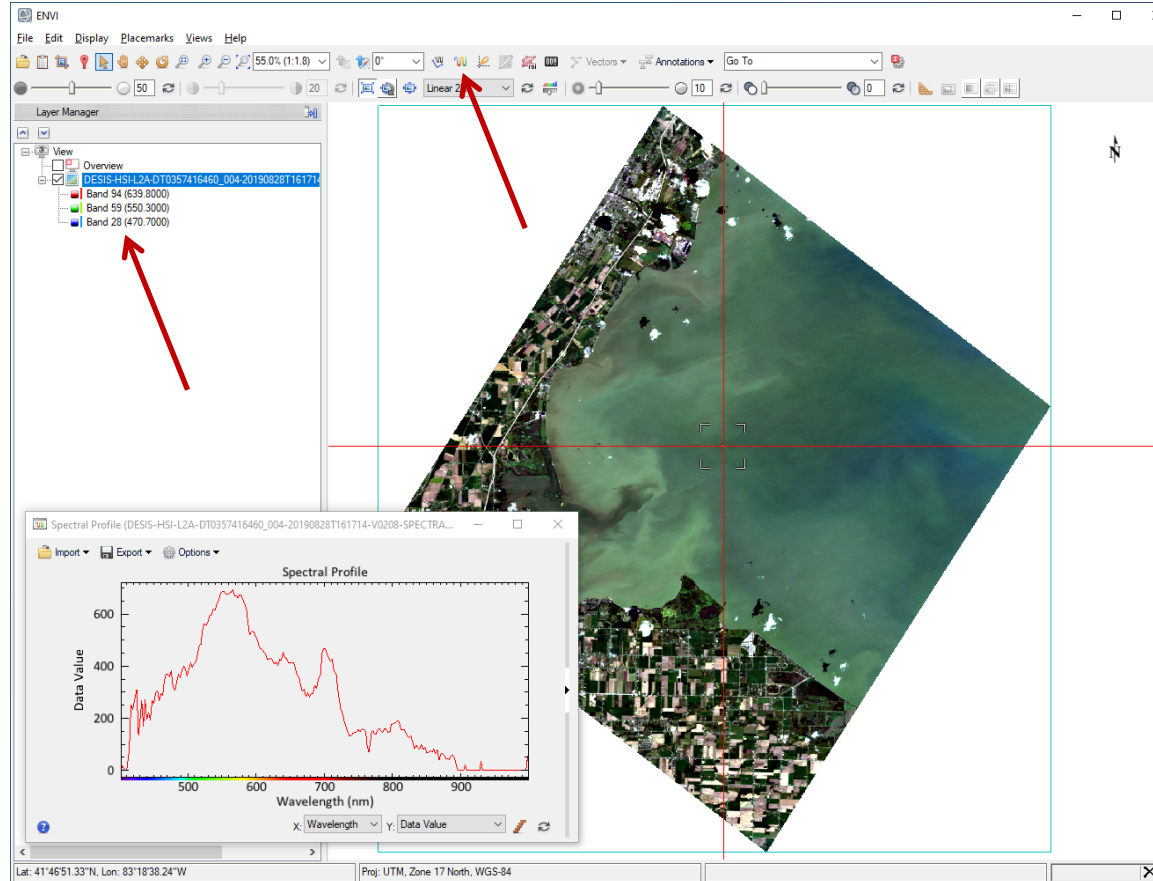

# Image Visualization

▶ **Georeferencing information included in the .hdr is also automatically applied by the image processing software**

- Orthorectified products (L1C and L2A) only

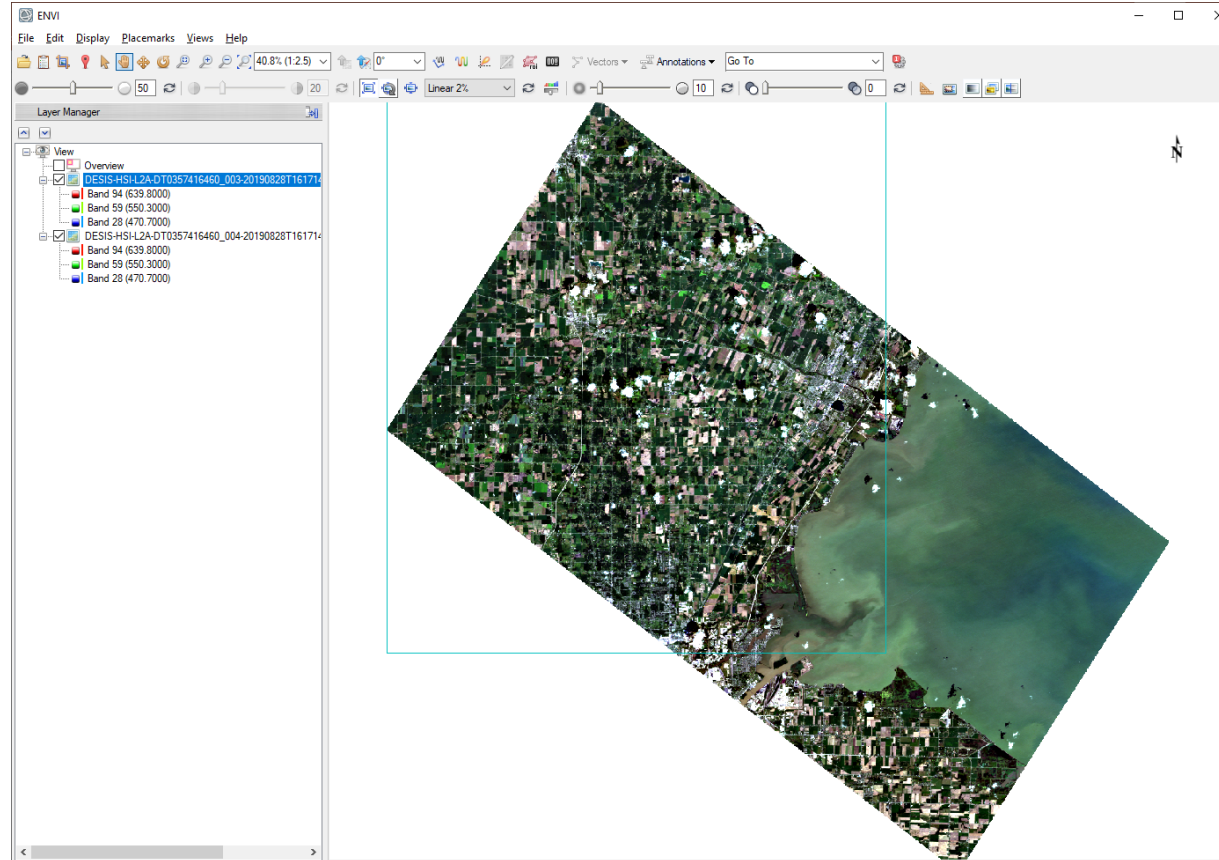

# Converting to Radiance/Reflectance

- ▶ **Hyperspectral imagery provided in int16 scaled DN format**
  - Gains and offsets provided in the .xml metadata for each spectral band convert the data to radiance (L1B, L1C) or reflectance (L2A)
    - Radiance units  $\text{mW cm}^{-2} \text{sr}^{-1} \mu\text{m}^{-1}$
- ▶ **The .hdr file included with each DESIS image also contains the gains and offsets and can be used to convert the data in ENVI**
  - Use the Apply Gains and Offsets function in the Toolboxes

$$L_{i,j,B} = G_B * DN_{i,j,B} + O_B$$

Where,  $L_{i,j,B}$  = Radiance (or reflectance) for pixel  $i,j$  per band,  $B$

$G_B$  = Gain per band,  $B$

$DN_{i,j,B}$  = DN for pixel  $i,j$  per band,  $B$

$O_B$  = Offset per band,  $B$

# Radiance/Reflectance Conversion in ENVI

## Apply Gain and Offset Tool in the Radiometric Correction Toolbox

- Converts L2A to reflectance
- Converts L1B, L1C to radiance
  - Can apply different atmospheric correction algorithm

## Floating point output radiance/reflectance

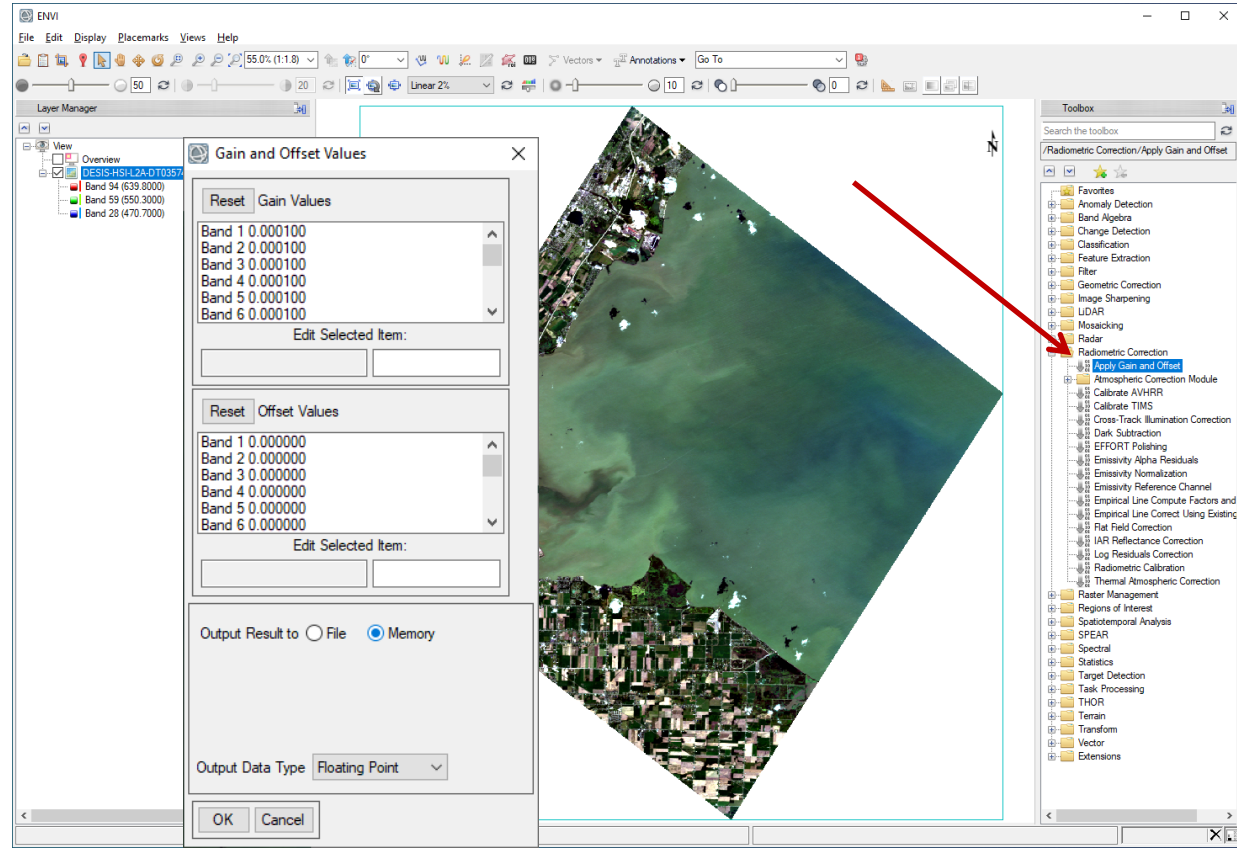

The screenshot displays the ENVI software interface. The main window shows a satellite image of a coastal area. A dialog box titled "Gain and Offset Values" is open, showing the following settings:

Band	Gain Value	Offset Value
Band 1	0.000100	0.000000
Band 2	0.000100	0.000000
Band 3	0.000100	0.000000
Band 4	0.000100	0.000000
Band 5	0.000100	0.000000
Band 6	0.000100	0.000000

The "Output Result to" option is set to "Memory". The "Output Data Type" is set to "Floating Point".

The "Radiometric Correction" toolbox is visible on the right side of the interface, with the "Apply Gain and Offset" tool highlighted by a red arrow.

# Radiance/Reflectance Conversion Output

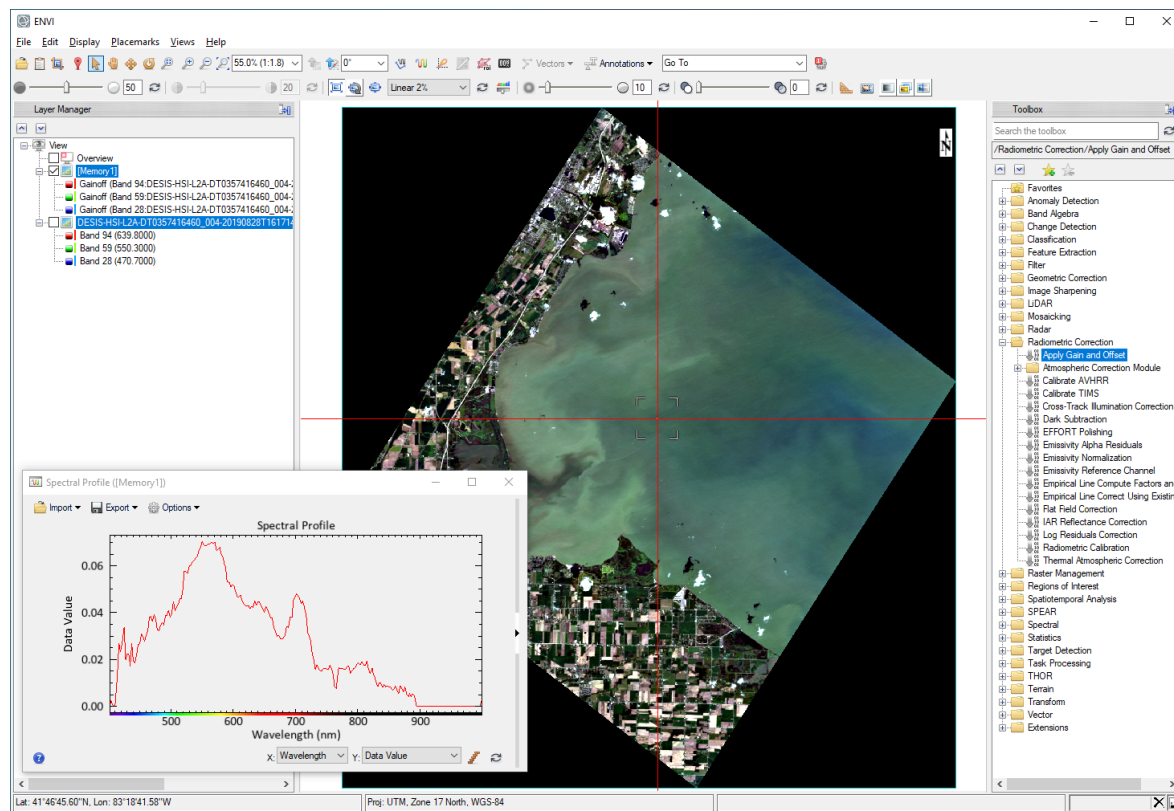

# Simple Product Generation

▶ ENVI toolbox has pre-built products and application (spectral indices, classification, feature extraction)

- Convert data to radiance or reflectance
- Apply desired tool

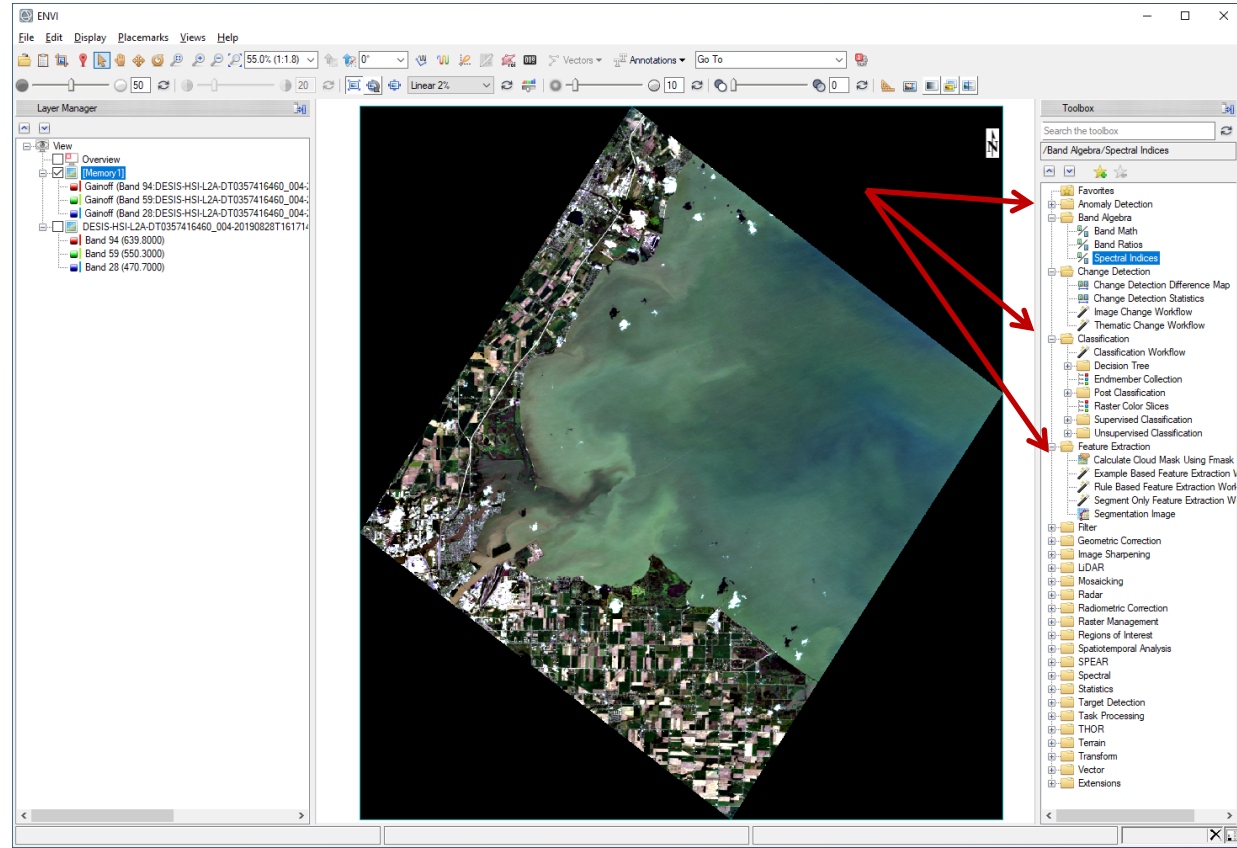



# Resources

- ▶ TCloud may be accessed at <https://teledyne.tcloudhost.com>
- ▶ Additional information about DESIS imagery, files and processing algorithms can be found at <https://tbe.com/geospatial/desis>
- ▶ **Contacts information**
  - TCloud access: Yvonne Ivey at [Yvonne.Ivey@nasa.gov](mailto:Yvonne.Ivey@nasa.gov)
  - TCloud operation or data ordering questions: Heath Lester at [Heath.Lester@Teledyne.com](mailto:Heath.Lester@Teledyne.com)
  - DESIS technical or calibration questions: Kara Burch at [kburch@i2rcorp.com](mailto:kburch@i2rcorp.com)

Everywhereyoulook™



**[www.tbe.com](http://www.tbe.com)**